



Shadow at its finest

TENDE A BRACCI. RETRACTABLES





Prodotto in Italia
Made in Italy



Motorizzate
Motorized



Versatili
Versatile



Illuminazione a led
Led lighting



FENG. LA PERFETTA

FENG. THE PERFECT ONE

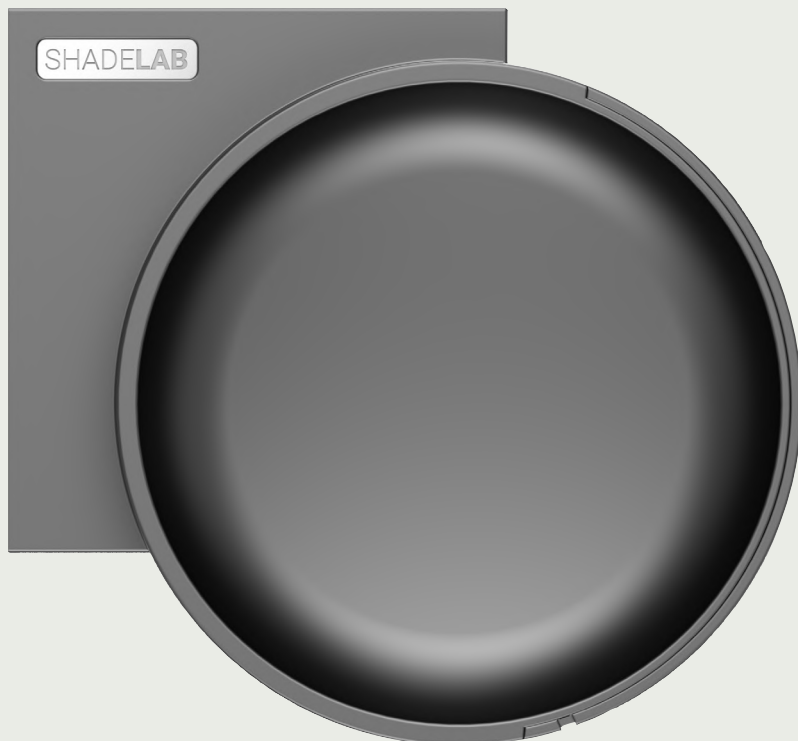

 **MAX 700x365 cm**

REGISTERED DESIGN 



Caratteristiche generali

- Tenda a cassonetto con bracci estensibili
- Installazione a parete e soffitto
- Inclinazione da 3° a 45° (35° braccio con LED)
- Tubo avvolgitore da 80 mm
- Braccio URBAN con DATSystem
- Optional nuovo Braccio URBAN LED
- Optional luce LED su cassonetto
- Dimensione massima modulo singolo 700x365 cm
- Solo motorizzata
- Sistema AcquaStop
- Regolazione micrometrica continua dell'inclinazione
- Viteria Inox certificata italiana
- Design brevettato in tutti gli stati della UE

General features

- Retractable arm awning with cassette
- Wall and ceiling installation
- Inclination ranges between 3° and 45° (35° LED ARM)
- Roller tube 80 mm
- Arm URBAN with DATSystem
- Available with new URBAN LED arm
- Available with cassette LED system
- Maximum sizes of a single section: 700x365 cm
- Only motorized
- AcquaStop System
- Continuous micrometric regulation of inclination
- Certified Italian Stainless steel screws and pins
- Design patented in all EU Member States

Feng. La perfetta. feng. the perfect one

Lunghezza del braccio e inclinazione
Arm lenght and inclination

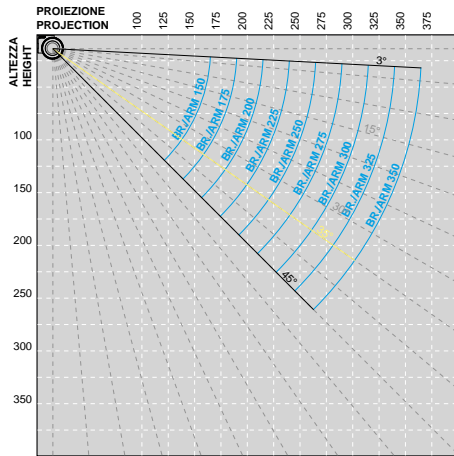

Le misure sono espresse in centimetri
Sizes are expressed in centimeters

Dimensioni della tenda chiusa
Awning sizes with folded arms

Installazione a parete
Wall installation

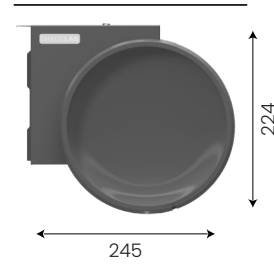

Inclinazione minima 3°
Inclinazione massima 45°
3° minimum inclination
45° maximum inclination

Installazione a soffitto
Ceiling installation

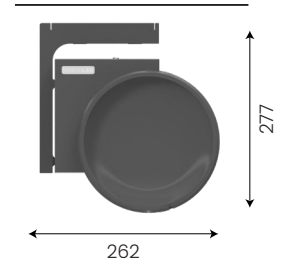

Inclinazione minima 3°
Inclinazione massima 45°
3° minimum inclination
45° maximum inclination

Le misure sono espresse in millimetri
Sizes are expressed in millimeters

Colori disponibili
Colours available

BISB bianco sablé
white sablé

GRSB grigio chiaro sablé
light grey sablé

AVSB avorio sablé
avory sablé

G900 grafite sablé
graphite sablé

Premi
Awards





SHAN. LA MAESTOSA

SHAN. THE MAJESTIC ONE



 **MAX 700x415 cm**

REGISTERED DESIGN 



Tested by:  **TÜVRheinland®**
Precisely Right.

Caratteristiche generali

- Tenda a cassonetto con bracci estensibili
- Installazione a parete o soffitto
- Inclinazione da 3° a 40°
- Tubo avvolgitore da 80 mm
- Braccio URBAN KATANA con DATSystem
- Dimensione massima modulo singolo 700x415 cm
- Solo motorizzata
- Sistema AcquaStop
- Regolazione micrometrica continua dell'inclinazione
- Viteria Inox certificata italiana
- Certificazione TÜV Rheinland
- Design brevettato in tutti gli stati della UE
- Vincitrice del Red Dot Design Award 2010

General features

- Retractable arm awning with cassette
- Wall and ceiling installation
- Inclination ranges between 0° and 40°
- Roller tube 80 mm
- Arm URBAN KATANA with DATSystem
- Maximum sizes of a single section: 700x415 cm
- Only motorized
- AcquaStop System
- Continuous micrometric regulation of inclination
- Certified Italian Stainless steel screws and pins
- Certified by TÜV Rheinland
- Design patented in all EU Member States
- 2010 Red Dot Design Award winner

Shan. La maestosa. shan. the majestic one

Lunghezza del braccio e inclinazione
Arm length and inclination

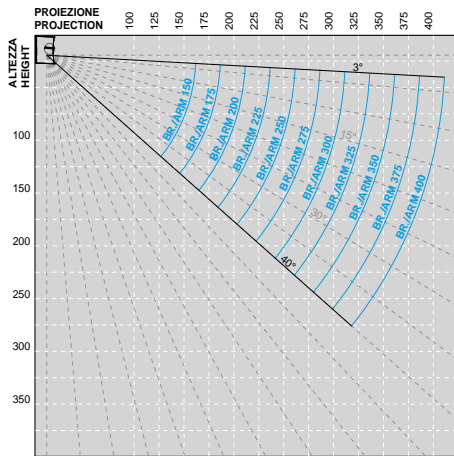

Le misure sono espresse in centimetri
Sizes are expressed in centimeters

Dimensioni della tenda chiusa
Awning sizes with folded arms

Installazione a parete
Wall installation

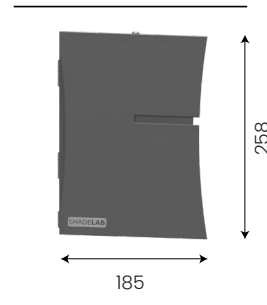

Inclinazione minima 3°
Inclinazione massima 40°
3° minimum inclination
40° maximum inclination

Installazione a soffitto
Ceiling installation

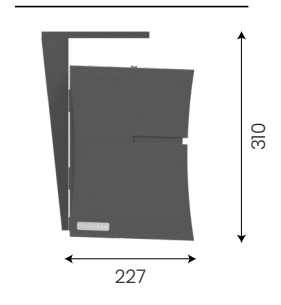

Inclinazione minima 3°
Inclinazione massima 40°
3° minimum inclination
40° maximum inclination

Le misure sono espresse in millimetri
Sizes are expressed in millimeters

Colori disponibili
Colours available

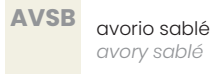

Premi
Awards





EDGE. LA PURA

EDGE. THE PURE

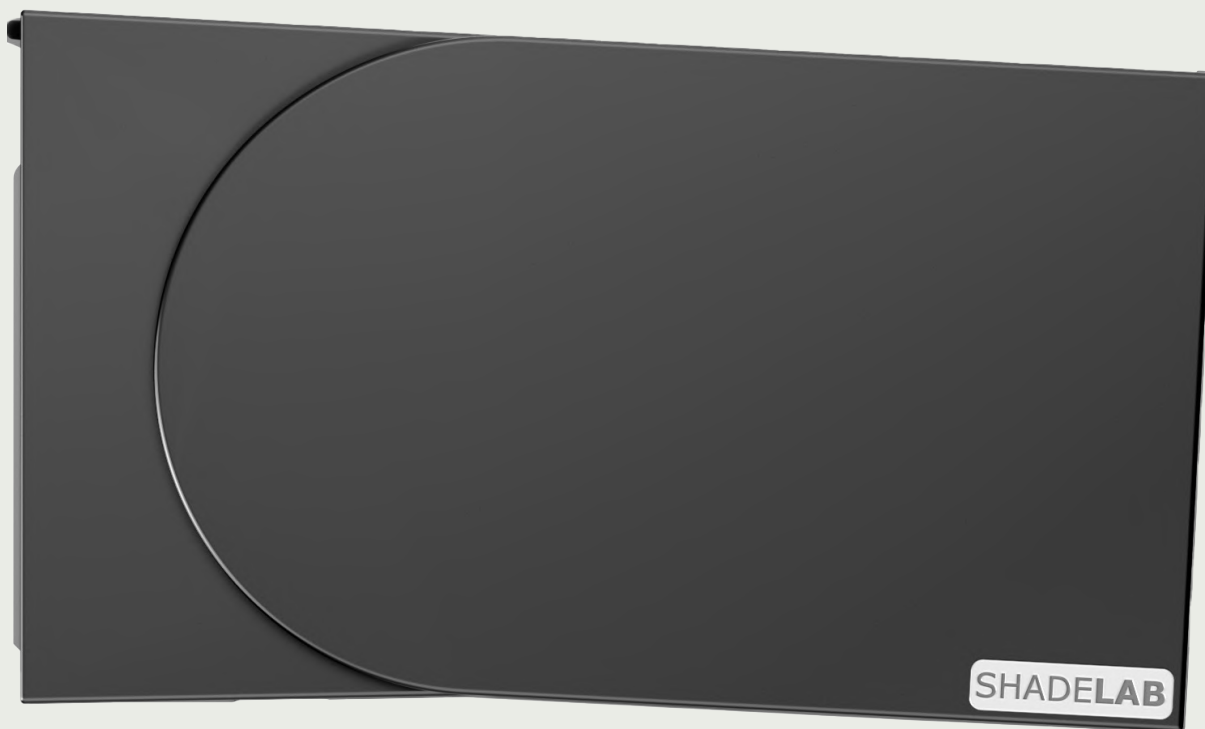

MAX 600x340 cm

REGISTERED DESIGN

Caratteristiche generali

- Tenda a cassonetto con bracci estensibili
- Installazione a parete e soffitto
- Inclinazione da 3° a 90°
- Tubo avvolgitore da 80 mm
- Braccio URBAN\KATANA con DATSystem
- Dimensione massima modulo singolo: 600x340 cm
- Manuale o motorizzata
- Led su bracci e cassonetto
- Regolazione micrometrica continua dell'inclinazione
- Viteria Inox certificata italiana
- Certificazione TÜV Rheinland
- Design brevettato in tutti gli stati della UE

General features

- Retractable arm awning with cassette
- Wall and ceiling installation
- Inclination ranges between 3° and 90°
- Roller tube 80 mm
- Arm URBAN\KATANA with DATSystem
- Maximum sizes of a single section: 600x340 cm
- Manually operated or motorized
- Led on arms and cassette
- Continuous micrometric regulation of inclination
- Certified Italian Stainless steel screws and pins
- Certified by TÜV Rheinland
- Design patented in all EU Member States

Lunghezza del braccio e inclinazione
Arm length and inclination

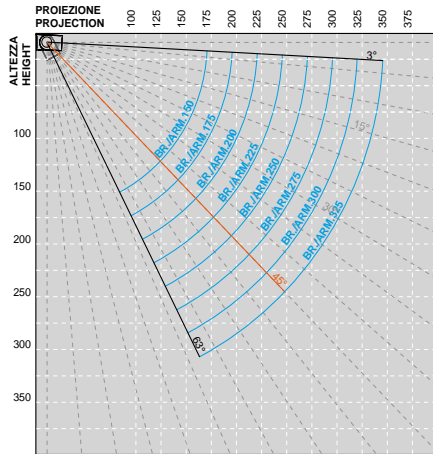

Le misure sono espresse in centimetri
Sizes are expressed in centimeters

Colori disponibili
Colours available

BISB bianco sablé
white sablé

GRSB grigio chiaro sablé
light grey sablé

AVSB avorio sablé
avory sablé

G900 grafite sablé
graphite sablé

Dimensioni della tenda chiusa
Awning sizes with folded arms

Installazione a parete
Wall installation

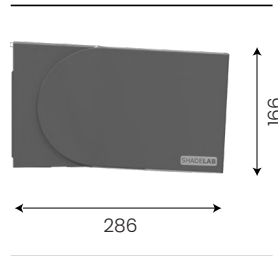

Inclinazione minima 3°
3° minimum inclination

Installazione a soffitto
Ceiling installation

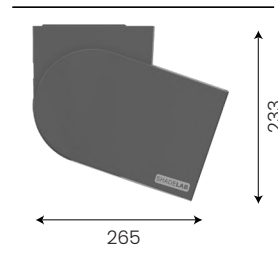

Inclinazione minima 16°
16° minimum inclination

Le misure sono espresse in millimetri
Sizes are expressed in millimeters

Installazione a parete
Wall installation

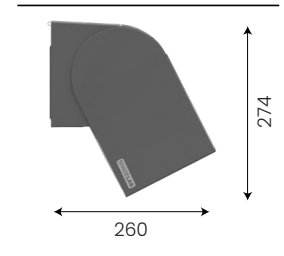

Inclinazione massima 63°
Maximum inclination 63°

Installazione a soffitto
Ceiling installation

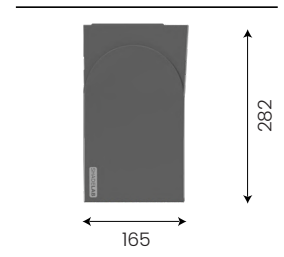

Inclinazione massima 90°
Maximum inclination 90°





KUMO. LA PIÙ AMATA

KUMO. THE MOST LOVED

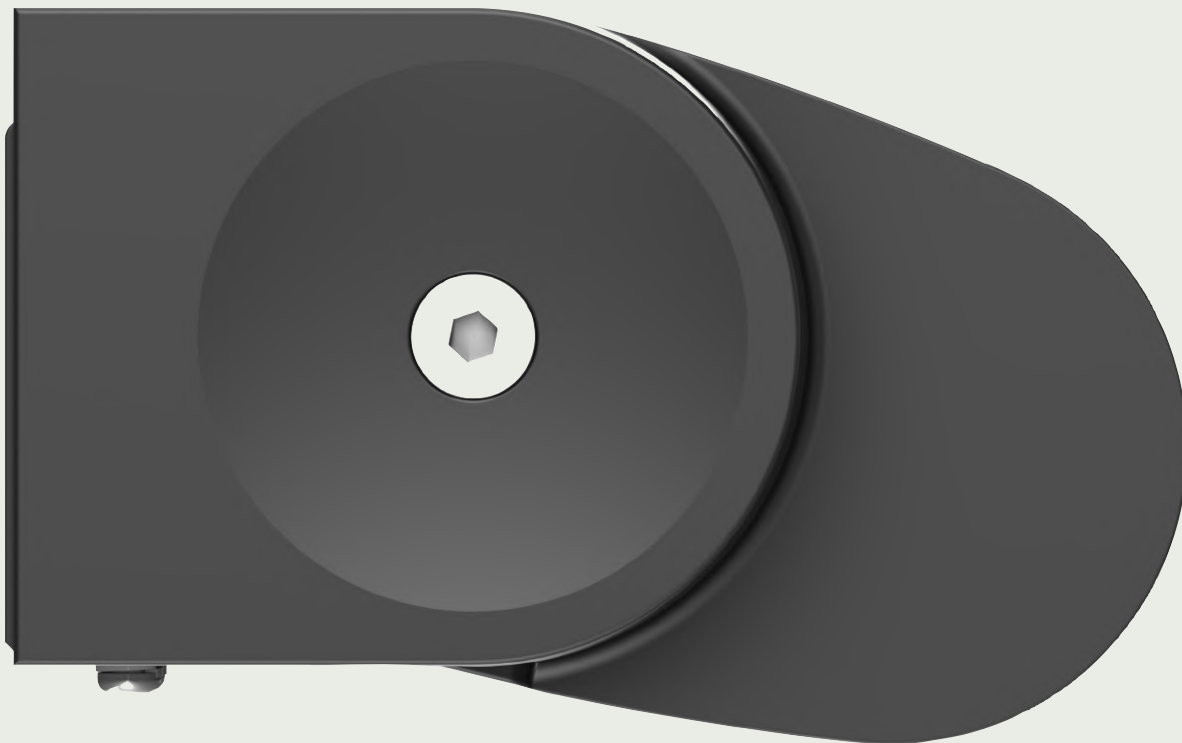

MAX 600x315 cm / 540x340 cm

REGISTERED DESIGN 



Tested by:  TÜVRheinland®
Precisely Right.

Caratteristiche generali

- Tenda a cassonetto con bracci estensibili
- Installazione a parete e soffitto
- Inclinazione da 5° a 85°
- Tubo avvolgitore da 80 mm
- Braccio HOME con DATSystem
- Dimensione massima modulo singolo 600x315 o 540x340 cm
- Manuale o motorizzata
- Regolazione micrometrica continua dell'inclinazione
- Viteria Inox certificata italiana
- Certificazione TÜV Rheinland
- Design brevettato in tutti gli stati della UE

General features

- Retractable arm awning with cassette
- Wall and ceiling installation
- Inclination ranges between 5° and 85°
- Roller tube 80 mm
- Arm HOME with DATSystem
- Maximum sizes of a single section: 600x315 or 540x340 cm
- Manually operated or motorized
- Continuous micrometric regulation of inclination
- Certified Italian Stainless steel screws and pins
- Certified by TÜV Rheinland
- Design patented in all EU Member States

Lunghezza del braccio e inclinazione
Arm lenght and inclination

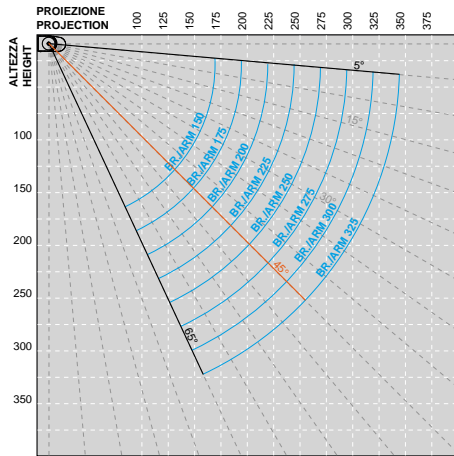

Le misure sono espresse in centimetri
Sizes are expressed in centimeters

Colori disponibili
Colours available

BISB	bianco sablé white sablé	GRSB	grigio chiaro sablé light grey sablé
AVSB	avorio sablé avory sablé	G900	grafite sablé graphite sablé

Dimensioni della tenda chiusa
Awning sizes with folded arms

Installazione a parete
Wall installation

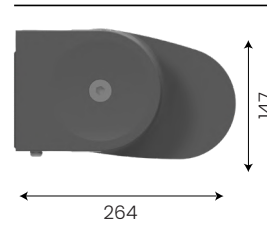

Inclinazione minima 5°
5° minimum inclination

Installazione a parete
Wall installation

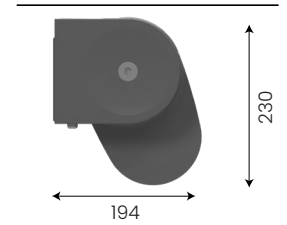

Inclinazione massima 65° motorizzata, 45° manuale
Maximum inclination 65° motorized, 45° manual

Installazione a soffitto
Ceiling installation

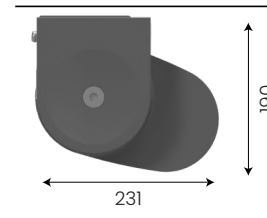

Inclinazione minima 13°
13° minimum inclination

Installazione a soffitto
Ceiling installation

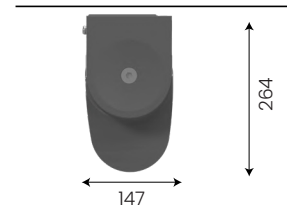

Inclinazione massima 85° motorizzata, 65° manuale
Maximum inclination 85° motorized, 65° manual

Le misure sono espresse in millimetri
Sizes are expressed in millimeters





YUKI. L'AGGRAZIATA

YUKI. THE GRACEFUL ONE

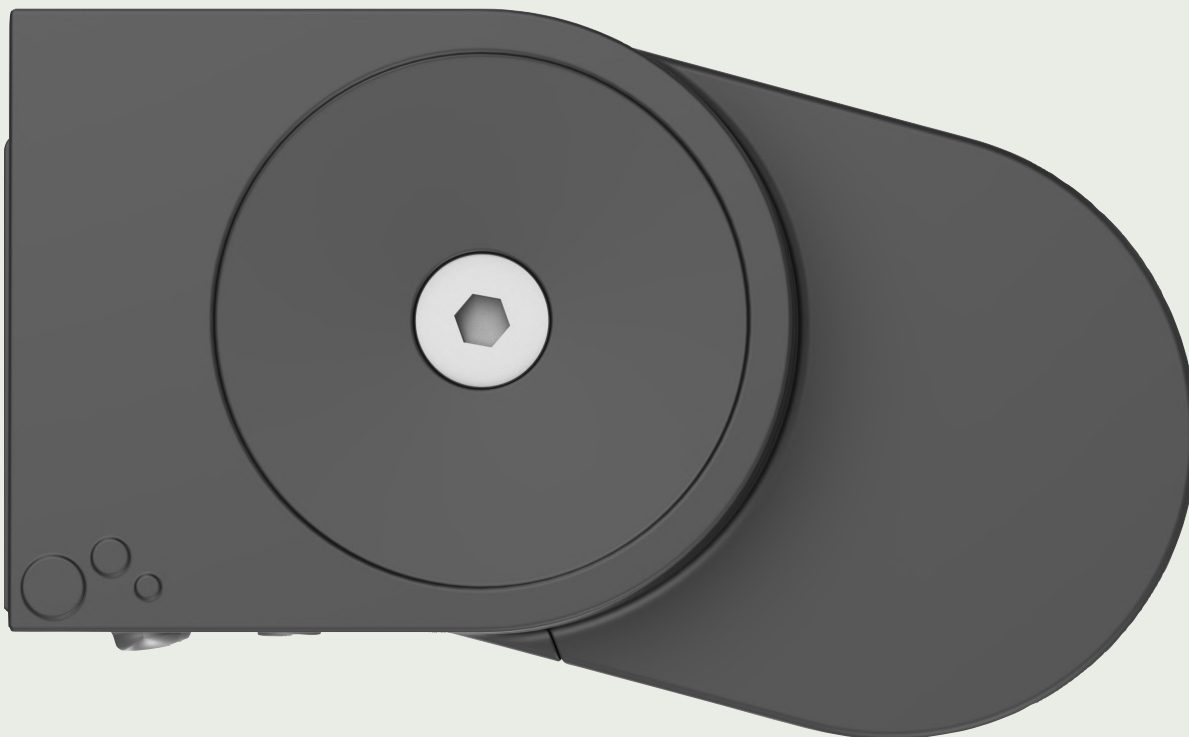

 **MAX 480x265 cm**

REGISTERED DESIGN 



Tested by:  **TÜVRheinland®**
Precisely Right.

Caratteristiche generali

- Tenda a cassonetto con bracci estensibili
- Viteria Inox certificata italiana
- Regolazione micrometrica dell'inclinazione
- Inclinazione da 3° a 90°
- Tubo avvolgitore da 80 mm
- Installazione a parete e soffitto
- Braccio FUSION con DATSystem
- Dimensione massima modulo singolo 480x265 cm
- Manuale o motorizzata

General features

- Retractable arm awning with cassette
- Certified Italian Stainless steel screws and pins
- Continuous micrometric regulation of inclination
- Inclination ranges between 3° and 90°
- Roller tube 80 mm
- Wall and ceiling installation
- Arm FUSION with DATSystem
- Maximum sizes of a single section: 480x265 cm
- Manually operated or motorized

Lunghezza del braccio e inclinazione
Arm lenght and inclination

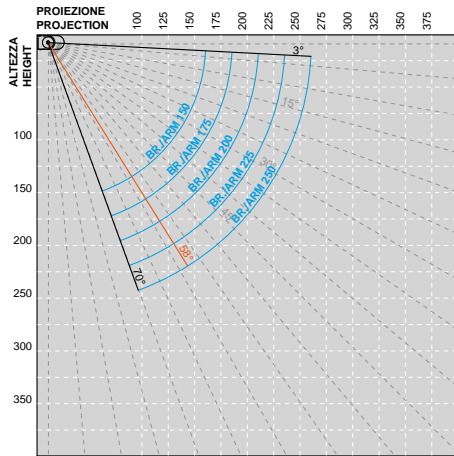

Le misure sono espresse in centimetri
Sizes are expressed in centimeters

Colori disponibili
Colours available

BISB	bianco sablé white sablé	GRSB	grigio chiaro sablé light grey sablé
AVSB	avorio sablé avory sablé	G900	grafite sablé graphite sablé

Dimensioni della tenda chiusa
Awning sizes with folded arms

Installazione a parete
Wall installation

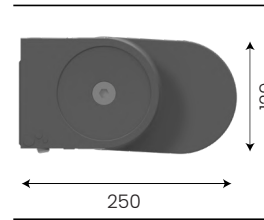

Inclinazione minima 3°
3° minimum inclination

Installazione a parete
Wall installation

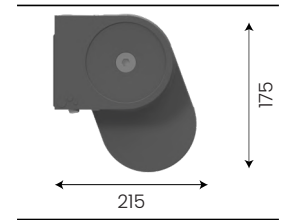

Inclinazione massima 70° motorizzata, 58° manuale
Maximum inclination 70° motorized, 58° manual

Installazione a soffitto
Ceiling installation

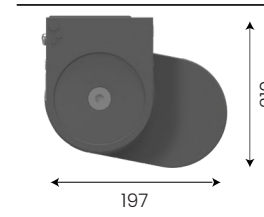

Inclinazione minima 11°
11° minimum inclination

Installazione a soffitto
Ceiling installation

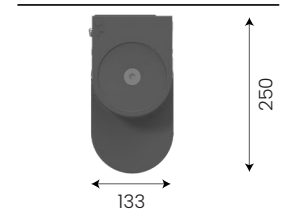

Inclinazione massima 90° motorizzata, 73° manuale
Maximum inclination 90° motorized, 73° manual

Le misure sono espresse in millimetri
Sizes are expressed in millimeters





ILIOS WING. L'ELEGANTE

ILIOS WING. THE ELEGANT ONE



MAX 400x160 cm

REGISTERED DESIGN 



Tested by:  **TÜVRheinland®**
Precisely Right.

Caratteristiche generali

- Cassonetto con terminale a totale scomparsa
- Installazione a parete e soffitto
- Tubo avvolgitore da 80 mm
- Dimensioni massime 400x160 cm (tessuto acrilico)
- Manuale o motorizzata
- Viteria Inox certificata italiana
- Certificazione TÜV Rheinland
- Design brevettato in tutti gli stati UE
- Disponibile con bracci a 90° o a 150°
- Vincitrice del Red Dot Design Award 2012

General features

- Terminal profile totally integrating with the box
- Wall and ceiling installation
- Roller tube 80 mm
- Maximum sizes 400x160 cm (acrylic fabric)
- Manually operated or motorized
- Certified Italian Stainless steel screws and pins
- Certified by TÜV Rheinland
- Design patented in all EU Member States
- Available with arms 90° or 150° inclination
- 2012 Red Dot Design Award winner

Ilios Wing. L'elegante. ilios wing. the elegant one

Dimensioni di ingombro
Overall dimensions

Installazione a parete o soffitto
Wall and ceiling installation

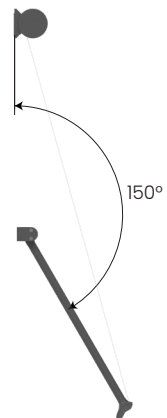
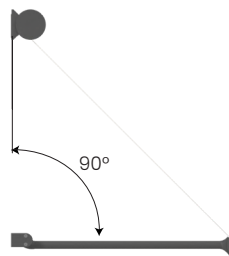
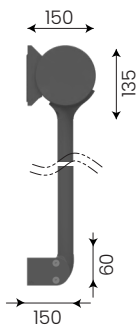
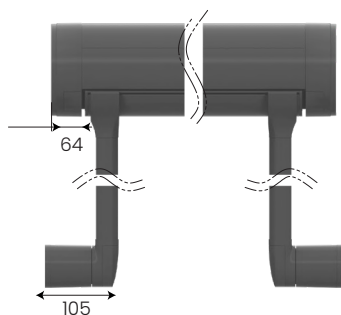

Le misure sono espresse in millimetri
Sizes are expressed in millimeters

Colori disponibili
Colours available

BISB bianco sablé
white sablé

GRSB grigio chiaro sablé
light grey sablé

AVSB avorio sablé
ivory sablé

G900 grafite sablé
graphite sablé

CORT corten
corten

Premi
Awards

 **reddot design award**
winner 2012





YAMA. L'INNOVATIVA

YAMA. THE INNOVATIVE ONE



MAX 700x415 cm

REGISTERED DESIGN 



Tested by:  TÜVRheinland®
Precisely Right.

Caratteristiche generali

- Viteria Inox certificata italiana
- Regolazione micrometrica dell'inclinazione
- Inclinazione da 3° a 60°
- Tubo avvolgitore da 80 mm
- Installazione a parete o soffitto (con staffe dedicate)
- Braccio URBAN KATANA con DATSystem
- Dimensione massima modulo singolo 700x415 cm
- Manuale o motorizzata
- Braccio URBAN KATANA LED
- Disponibile o con opzione led sui bracci o sul terminale
- Supporti braccio rinforzati
- Certificazione TÜV Rheinland

General features

- Certified Italian Stainless steel screws and pins
- Continuous micrometric regulation of inclination
- Inclination ranges between 3° and 60°
- Roller tube 80 mm
- Wall and ceiling installation (with dedicated brackets)
- Arm URBAN KATANA with DATSystem
- Maximum sizes of a single section: 700x415 cm
- Manually operated or motorized
- Urban URBAN KATANA LED arm
- Available or with LED option on the arms or on the terminal
- Reinforced arm supports
- Certified by TÜV Rheinland

Lunghezza del braccio e inclinazione
Arm length and inclination

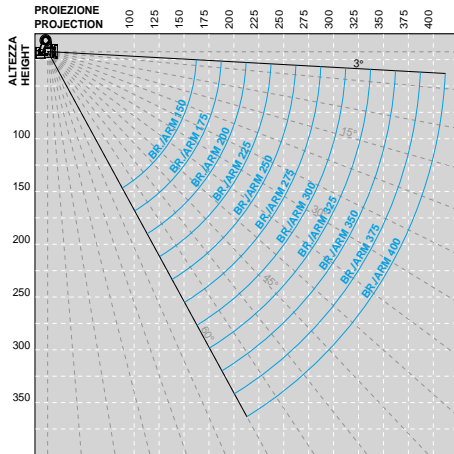

Le misure sono espresse in centimetri
Sizes are expressed in centimeters

Colori disponibili
Colours available



Dimensioni della tenda chiusa
Awning sizes with folded arms

Installazione a parete
Wall installation

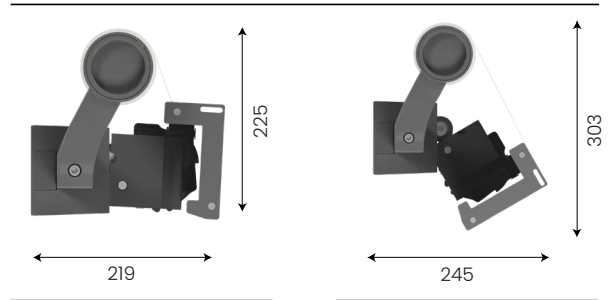

Inclinazione minima 3°
3° minimum inclination

Inclinazione massima 60°
60° Maximum inclination

Installazione a soffitto
Ceiling installation

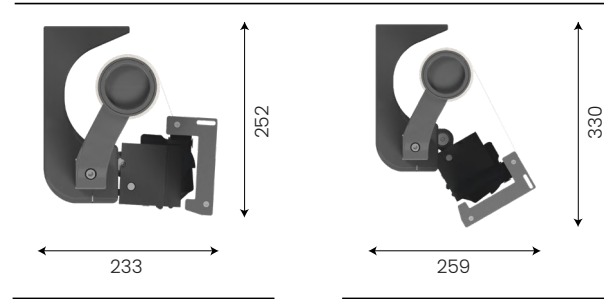

Inclinazione minima 3°
3° minimum inclination

Inclinazione massima 60°
60° Maximum inclination

Le misure sono espresse in millimetri
Sizes are expressed in millimeters





SVET. L'ORIGINALE

SVET. THE ORIGINAL ONE

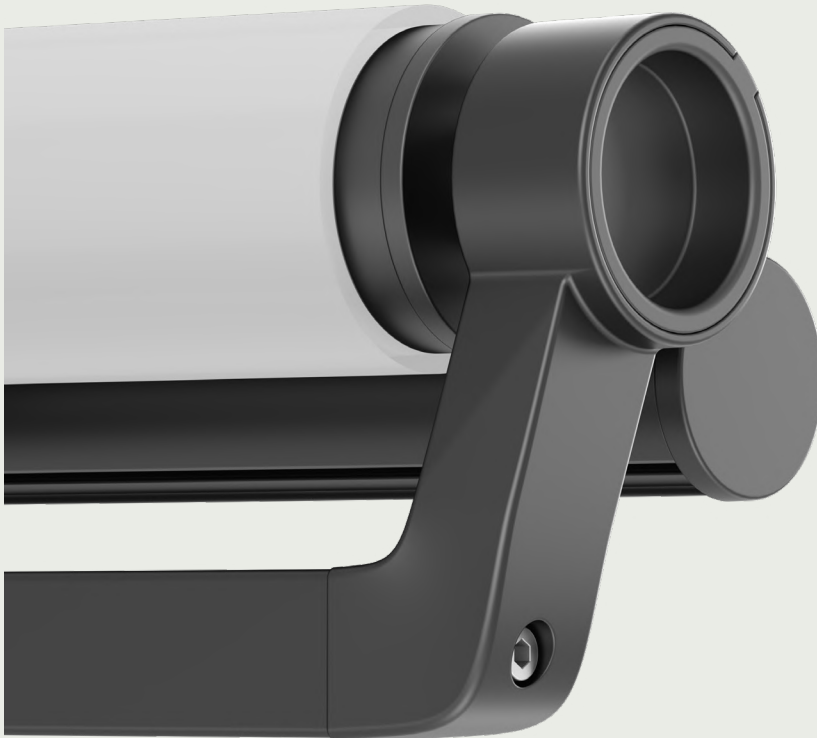

MAX 700x315 cm

REGISTERED DESIGN 



Tested by:  **TÜVRheinland®**
Precisely Right.



Caratteristiche generali

- Viteria Inox certificata italiana
- Installazione a parete o a soffitto (con staffe Klip)
- Regolazione micrometrica continua dell'inclinazione
- Inclinazione da 3° a 40°
- Tubo avvolgitore da 80 mm
- Braccio URBAN con DATSystem
- Dimensione massima modulo singolo 700x315 cm
- Manuale o motorizzata
- Disponibile con tettuccio protettivo
- Certificazione TÜV Rheinland

General features

- *Certified Italian Stainless steel screws and pins*
- *Wall and ceiling installation (with Klip bracket)*
- *Continuous micrometric regulation of inclination*
- *Inclination ranges between 3° and 40°*
- *Roller tube 80 mm*
- *Arm urban with DATSystem*
- *Maximum sizes of a single section: 700x315 cm*
- *Manually operated or motorized*
- *Available with protective hood*
- *Certified by TÜV Rheinland*

Svet. L'originale. svet. the original one

Lunghezza del braccio e inclinazione
Arm length and inclination

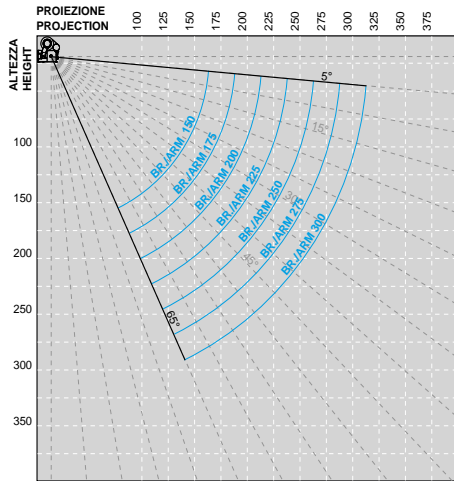

Le misure sono espresse in centimetri
Sizes are expressed in centimeters

Colori disponibili
Colours available

BISB bianco sablé
white sablé

G900 grafite sablé
graphite sablé

Dimensioni della tenda chiusa
Awning sizes with folded arms

Installazione a parete
Wall installation

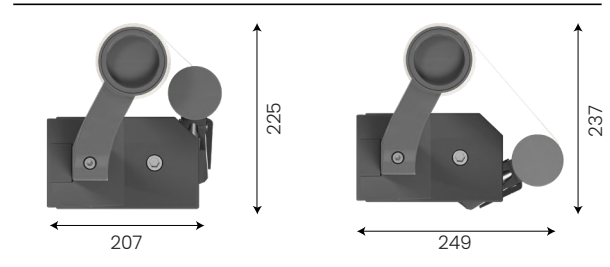

Inclinazione minima 3°
3° minimum inclination

Inclinazione massima 65°
65° Maximum inclination

Installazione a soffitto
Ceiling installation

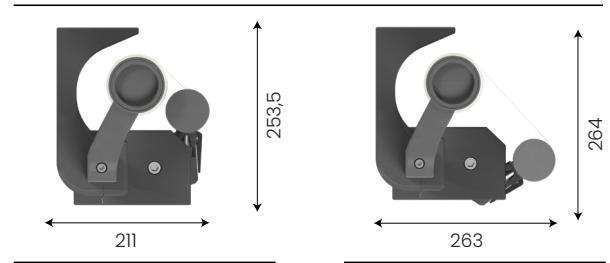

Inclinazione minima 3°
3° minimum inclination

Inclinazione massima 60°
60° Maximum inclination

Le misure sono espresse in millimetri
Sizes are expressed in millimeters





KLIP. LA SEDUCENTE

KLIP. THE SEDUCTIVE ONE

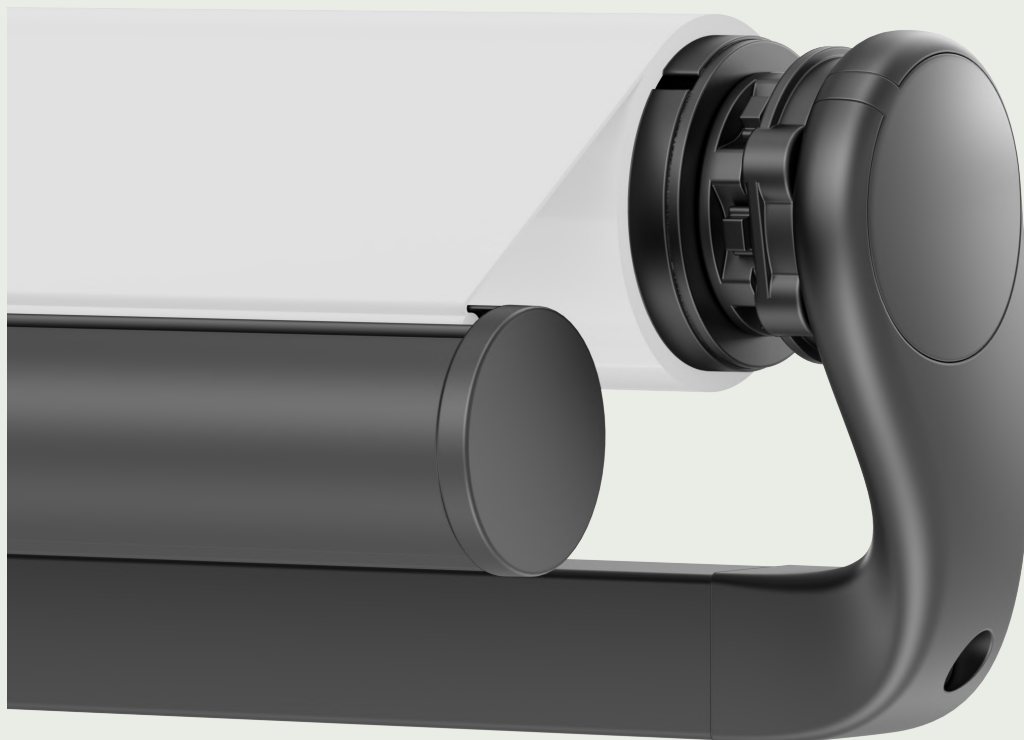

 **MAX 700x365 cm**

REGISTERED DESIGN 

 5 YEARS GUARANTEED

Tested by:  TÜVRheinland®
Precisely Right.

Caratteristiche generali

- Dimensione massima modulo singolo 700x365 cm
- Tubo avvolgitore da 80 mm
- Braccio Home con DATSystem
- Manuale o motorizzata
- Regolazione micrometrica continua dell'inclinazione
- Disponibile con tettuccio protettivo
- Viteria Inox certificata italiana
- Certificazione TÜV Rheinland
- Design brevettato in tutti gli stati della UE
- Installazione a parete o soffitto
- Inclinazione da 5° a 65°

General features

- Maximum sizes of a single section: 700x365 cm
- Roller tube 80 mm
- Arm HOME with DATSystem
- Manually operated or motorized
- Continuous micrometric regulation of inclination
- Available with protective hood
- Certified Italian Stainless steel screws and pins
- Certified by TÜV Rheinland
- Design patented in all EU Member States
- Wall or ceiling installation
- Inclination ranges between 5° and 65°

Klip. La seducente. klip. the seductive one

Lunghezza del braccio e inclinazione
Arm length and inclination

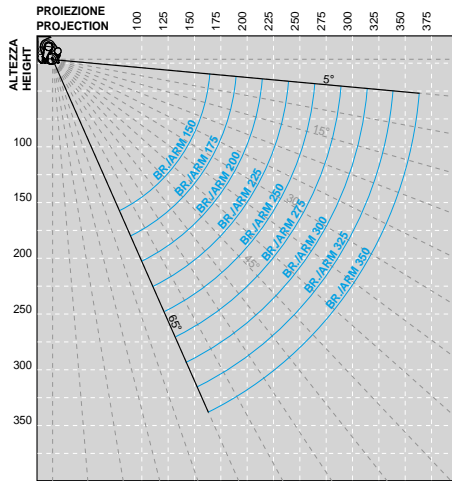

Le misure sono espresse in centimetri
Sizes are expressed in centimeters

Dimensioni della tenda chiusa
Awning sizes with folded arms

Installazione a parete o soffitto o nicchia
Wall or ceiling or niche installation

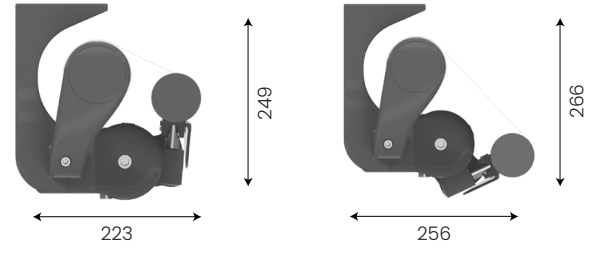

Inclinazione minima 5°
5° minimum inclination

Inclinazione massima 65°
65° Maximum inclination

Le misure sono espresse in millimetri
Sizes are expressed in millimeters

Colori disponibili
Colours available



B1SB bianco sablé
white sablé



G900 grafite sablé
graphite sablé

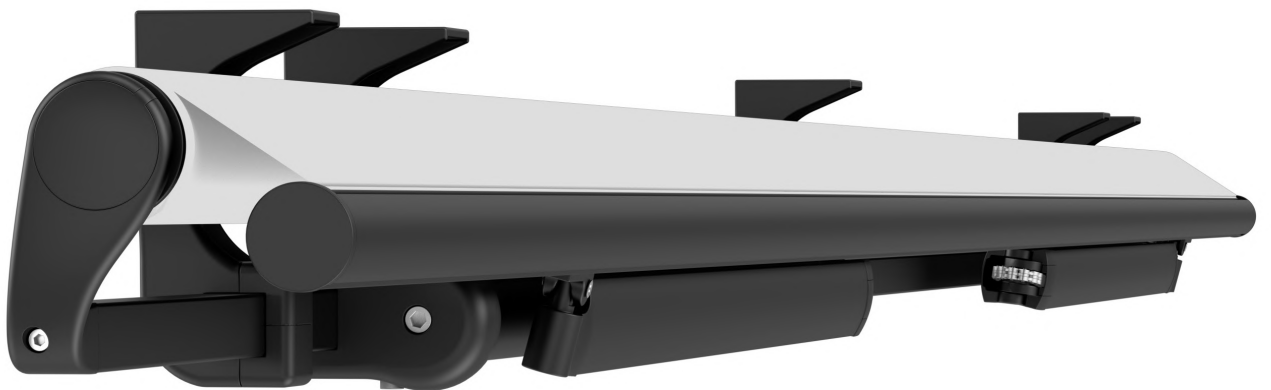



STEIN. L'INTRIGANTE

STEIN. THE INTRIGUING ONE

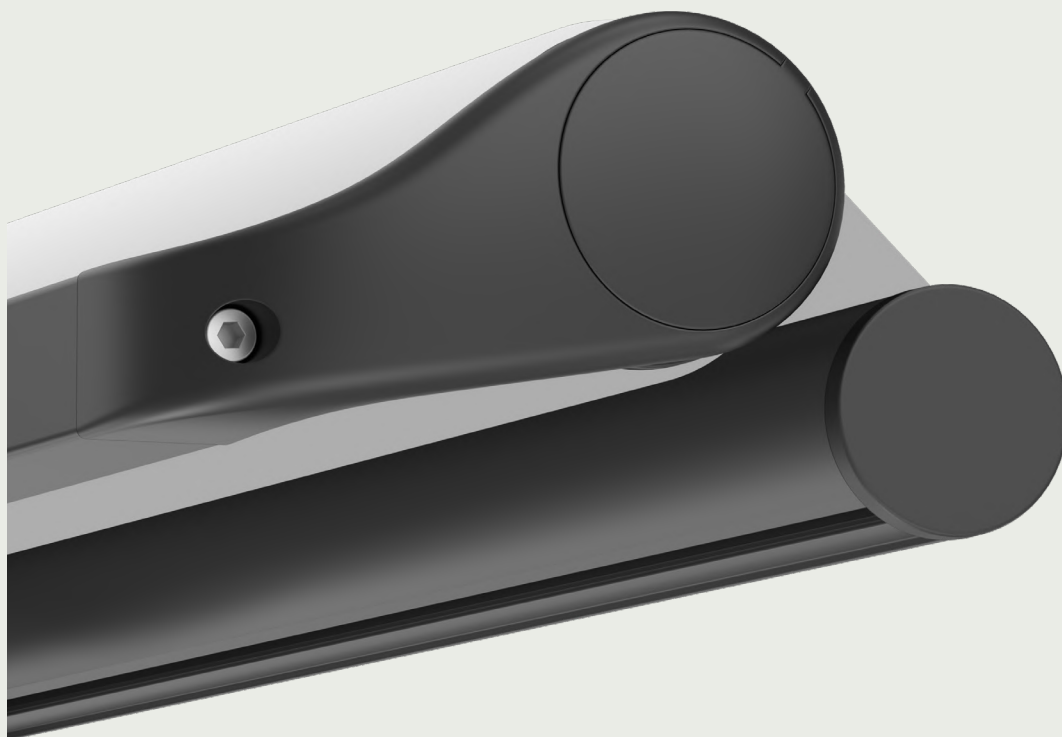

 **MAX 700x365 cm**

REGISTERED DESIGN 



Tested by:  **TÜVRheinland®**
Precisely Right.

Caratteristiche generali

- Dimensione massima modulo singolo 700x365 cm
- Tubo avvolgitore da 80 mm
- Braccio Home con DATSystem
- Manuale o motorizzata
- Regolazione micrometrica continua dell'inclinazione
- Disponibile con tettuccio protettivo
- Viteria Inox certificata italiana
- Certificazione TÜV Rheinland
- Design brevettato in tutti gli stati della UE
- Installazione a parete o soffitto
- Inclinazione da 5° a 85°
- Optional nuovo braccio URBAN LED

General features

- *Maximum sizes of a single section: 700x365 cm*
- *Roller tube 80 mm*
- *Arm HOME with DATSystem*
- *Manually operated or motorized*
- *Continuous micrometric regulation of inclination*
- *Available with protective hood*
- *Certified Italian Stainless steel screws and pins*
- *Certified by TÜV Rheinland*
- *Design patented in all EU Member States*
- *Wall or ceiling installation*
- *Inclination ranges between 5° and 85°*
- *New URBAN LED Arm available*

Stein. L'intrigante. stein. the intriguing one

Lunghezza del braccio e inclinazione
Arm length and inclination

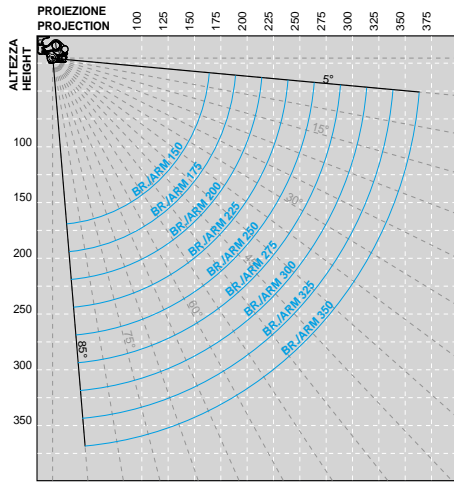

Le misure sono espresse in centimetri
Sizes are expressed in centimeters

Dimensioni della tenda chiusa
Awning sizes with folded arms

Installazione a parete o soffitto
Wall or ceiling installation

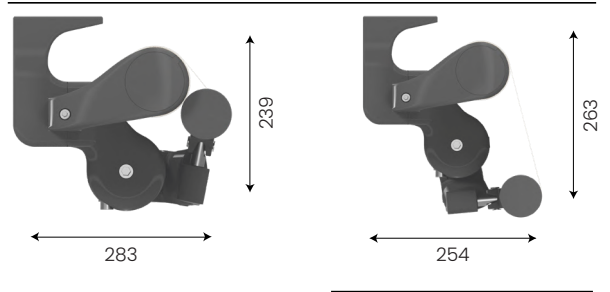

Inclinazione minima 5°
5° minimum inclination

Inclinazione massima 85°
85° Maximum inclination

Le misure sono espresse in millimetri
Sizes are expressed in millimeters

Colori disponibili
Colours available



bianco sablé
white sablé



grafite sablé
graphite sablé

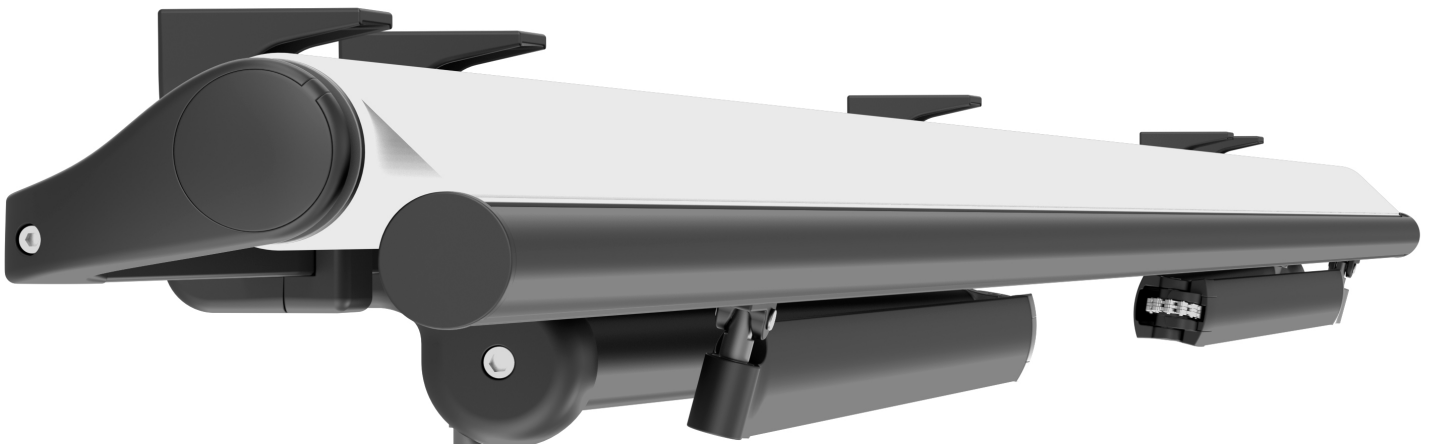



PIUMA. LA LEGGERA

PIUMA. THE LIGHT ONE

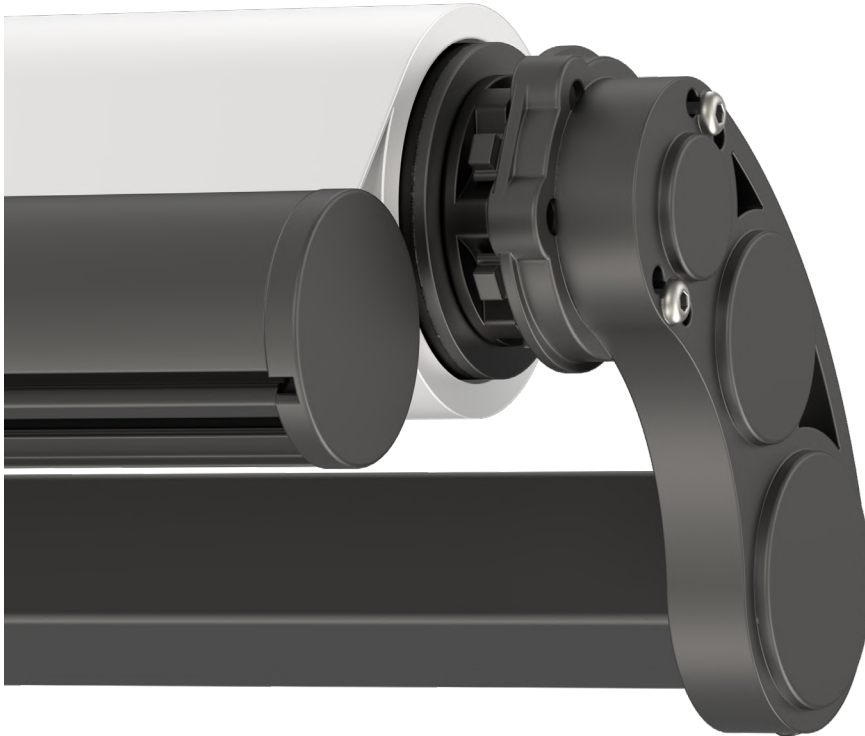

 **MAX 700x315 cm**

REGISTERED DESIGN 



Caratteristiche generali

- Dimensione massima modulo singolo 700x315 cm
- Tubo avvolgitore da 80 mm
- Braccio FUSION con DATSystem
- Manuale o motorizzata (per manuale si consiglia dimensione massima 600x265 cm)
- Regolazione micrometrica continua dell'inclinazione
- Disponibile con tettuccio protettivo
- Viteria Inox certificata italiana
- Design brevettato in tutti gli stati della UE
- Installazione a parete o soffitto
- Inclinazione da 0° a 90°

General features

- Maximum sizes of a single section: 700x315 cm
- Roller tube 80 mm
- Arm FUSION with DATSystem
- Manually operated or motorized (by manual we recommend maximum size 600x265 cm)
- Continuous micrometric regulation of inclination
- Available with protective hood
- Certified Italian Stainless steel screws and pins
- Design patented in all EU Member States
- Wall or ceiling installation
- Inclination ranges between 0° and 90°

Piuma. La leggera. piuma. the light one

Lunghezza del braccio e inclinazione
Arm length and inclination

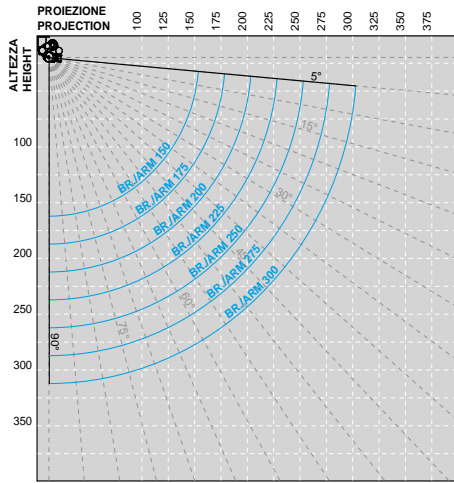

Le misure sono espresse in centimetri
Sizes are expressed in centimeters

Dimensioni della tenda chiusa
Awning sizes with folded arms

Installazione a parete o soffitto
Wall or ceiling installation

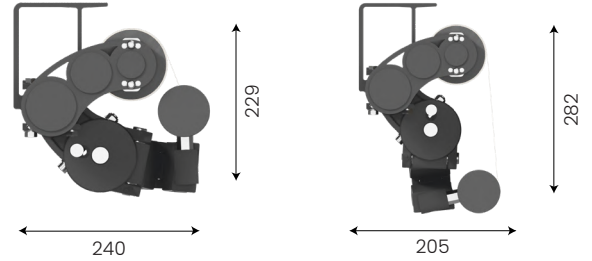

Inclinazione minima 0°
0° minimum inclination

Inclinazione massima 90°
90° Maximum inclination

Le misure sono espresse in millimetri
Sizes are expressed in millimeters

Colori disponibili
Colours available



TENDE ORIZZONTALI. HORIZONTALS

LOCATION

Australia - Queensland

CREDITS

Progetto ed installazione gestite da: TurnerArc
turnerarc.com.au

Assemblatore: FHA Wholesale
www.fhawholesale.com.au

Project installed & managed by: TurnerArc
turnerarc.com.au

Manufacturer: FHA Wholesale
www.fhawholesale.com.au





Prodotto in Italia
Made in Italy



Ottima copertura dai raggi solari
Excellent coverage from the sun's rays



Versatili
Versatile



FRAME. L'AUDACE

FRAME. THE BOLD ONE



 **MAX 500x600cm**
MIN INC 15° / MIN INC 8°

REGISTERED DESIGN 



Tubo 

Caratteristiche generali

- Tubo avvolgitore da 100 mm
- Dimensione massima 500x600 cm
- Inclinazione minima senza blocco automatico: 15°
- Inclinazione minima con blocco automatico: 8°
- Disponibile solo motorizzata
- Pistoni a gas e cinghia
- Viteria Inox certificata italiana
- Installazione a parete e con piedini
- Vincitrice dell'Iconic Award 2016

General features

- Roller tube 100 mm
- Maximum sizes 500x600 cm
- Minimum inclination without locking system: 15°
- Minimum inclination with locking system: 8°
- Only motorized
- Gas pistons and belt
- Certified Italian Stainless steel screws and pins
- Installation on wall and with feet
- 2016 Iconic Award winner

Dimensioni di ingombro
Overall dimensions

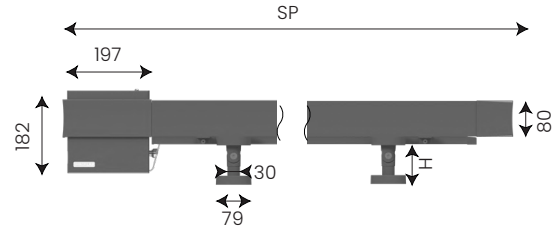
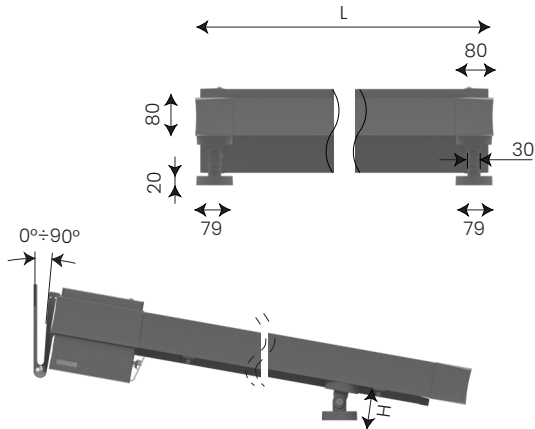

Accessori
Optionals

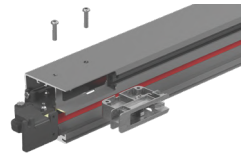

Blocco automatico per
tensionamento del telo
Automatic locking system
for fabric tension

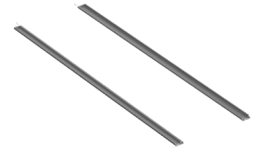

Gronde laterali con LED
Side gutter with LED

Le misure sono espresse in millimetri
Sizes are expressed in millimeters

Colori disponibili
Colours available

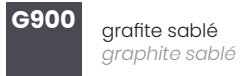
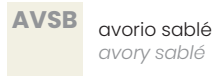

Premi
Awards



Iconic award
2016





KENJI. LA REGINA

KENJI. THE QUEEN



 **MAX 400x500cm**
MIN INC 15° / MIN INC 8°

REGISTERED DESIGN 



Caratteristiche generali

- Tubo avvolgitore da 100 mm
- Dimensione massima 400x500 cm
- Inclinazione minima senza blocco automatico: 15°
- Inclinazione minima con blocco automatico: 8°
- Disponibile solo motorizzata
- Pistoni a gas e cinghia
- Viteria Inox certificata italiana

General features

- Roller tube 100 mm
- Maximum sizes 400x500 cm
- Minimum inclination without locking system: 15°
- Minimum inclination with locking system: 8°
- Only motorized
- Gas pistons and belt
- Certified Italian Stainless steel screws and pins

Dimensioni di ingombro
Overall dimensions

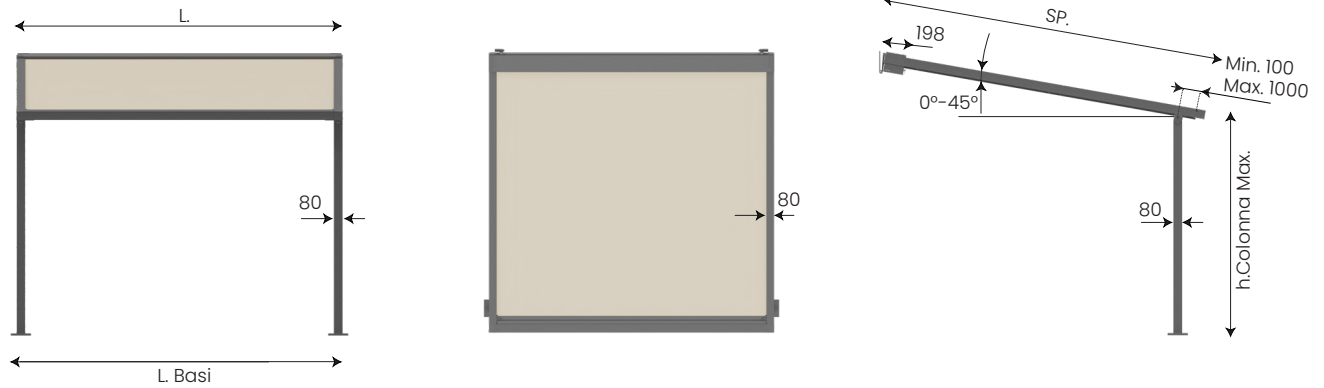

Le misure sono espresse in millimetri
Sizes are expressed in millimeters

Colori disponibili
Colours available

BISB bianco sablé
white sablé

GRSB grigio chiaro sablé
light grey sablé

AVSB avorio sablé
ivory sablé

G900 grafite sablé
graphite sablé

CORT corten
corten

Accessori
Optionals

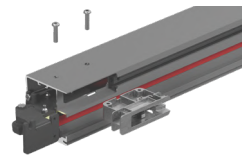

Blocco automatico per
tensionamento del telo
Automatic locking system
for fabric tension

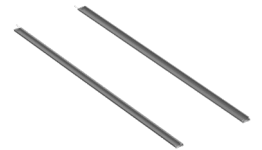

Grande laterali con LED
Side gutter with LED





LEAF. LA SCELTA GIUSTA

LEAF. THE GOOD CHOICE

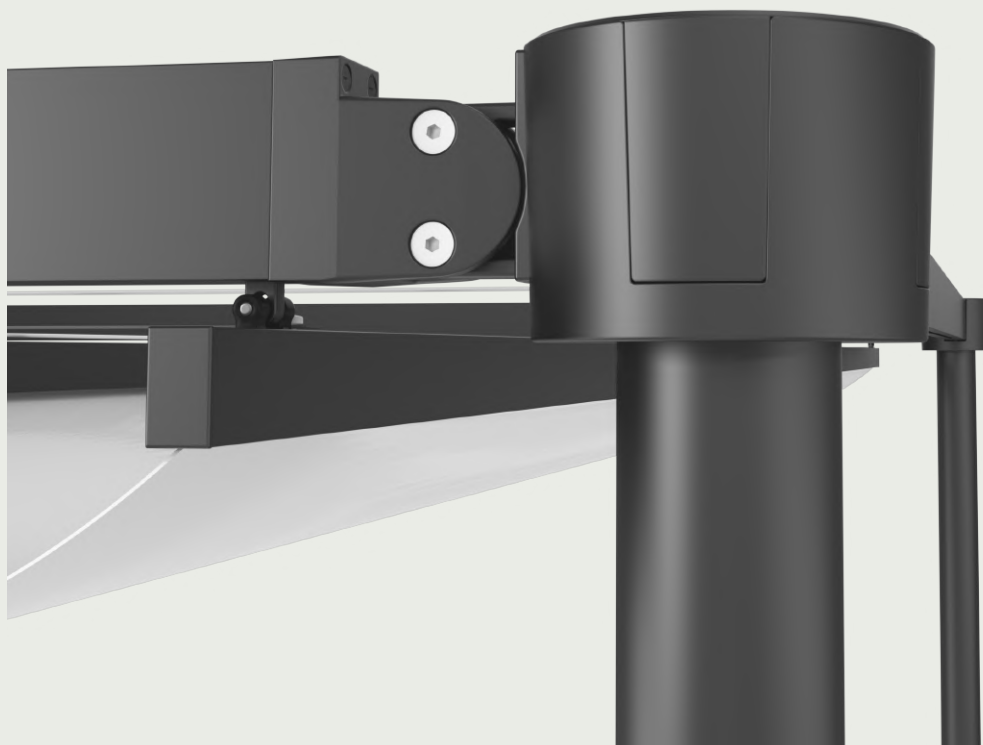

 **MAX 500x500cm**

REGISTERED DESIGN 

 5
YEARS
WARRANTY

PATENTED 

 ANTI
PIOGGIA

Caratteristiche generali

- Misura massima modulo singolo 500x500 cm
- Design e tecnologia brevettati
- Certificato TÜV Rheinland
- Modulare: offre la possibilità di giuntare moduli per coprire qualsiasi metratura
- Versione manuale o motorizzata
- Possibilità di aggiungere il tettuccio protettivo (non per Sky)
- Telo con onde o telo dritto (no teso)
- Struttura completamente in alluminio
- Viteria Inox certificata Italiana
- Telo smontabile facilmente per pulizia
- Carrellini scorrevoli su cuscinetti
- Nessuna vite in vista

General features

- Maximum sizes of a single section: 500x500 cm
- Patented design and technology
- Certified by TÜV Rheinland
- Modular: it can be coupled infinitely to cover any size
- Manually operated or motorized
- Optional protective hood (not for the Sky version)
- Fabric can be either with waves or straight (not tensioned)
- Structure is totally in aluminium
- Certified Italian Stainless steel screws and pins
- Fabric can be easily removed for cleaning and maintenance
- Fabric-hanging sliding systems on bearings
- No visible screws

LEAF GROUND

- 4 colonne portanti
- Altezza standard 250 cm, massimo 300 cm
- Possibilità larghezza 600 cm con colonne a 500 cm
- Possibilità moduli giuntati ad altezze differenti
- Possibilità impacchettamento telo su entrambi i lati
- Possibilità chiusura laterale con tende a caduta
- Possibilità inclinazione telo per scarico acqua

- 4 load-bearing columns
- Column standard height: cm 250; maximum 300 cm
- Width can be 600 cm with columns at 500 cm
- Sections can be coupled at different heights
- Fabric can be closed on both sides
- Lateral drop awnings can be installed to close the structure
- Fabric can be inclined for water draining

Installazione a 4 colonne
Installation on 4 columns

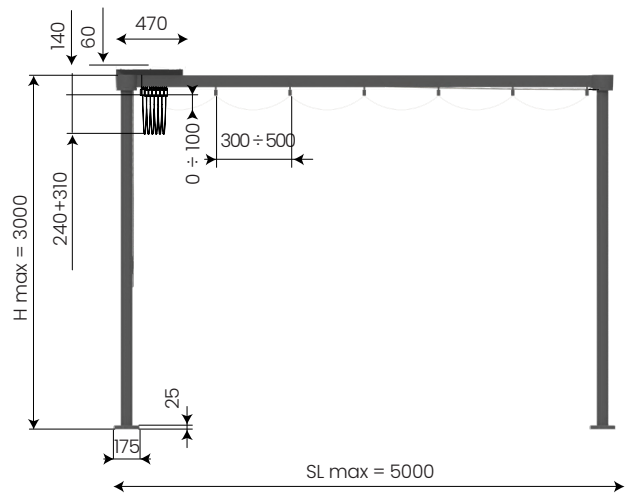
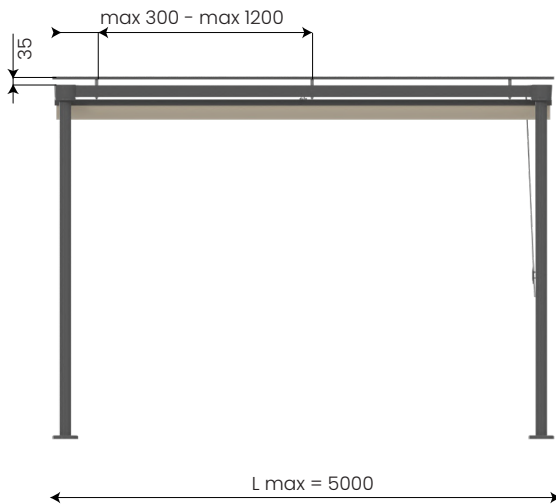

Le misure sono espresse in millimetri
Sizes are expressed in millimeters

Colori disponibili
Colours available

BISB bianco sablé
white sablé

G900 grafite sablé
graphite sablé



LEAF FALL

- 2 colonne e attacco parete/soffitto
- Altezza standard colonne 250 cm, massimo 300 cm
- Possibilità larghezza 600 cm con colonne a 500 cm
- Dritta o inclinata fino a 20°
- Possibilità impacchettamento telo su entrambi i lati
- Possibilità chiusura frontale con tenda a caduta

- 2 columns and wall/ceiling installation
- Column standard height: cm 250; maximum 300 cm
- Width can be 600 cm with columns at 500 cm
- Straight or inclined up to 20°
- Fabric can be closed on both sides
- A drop awning can be installed on the front to close the structure

Installazione a 2 colonne
Installation on 2 columns

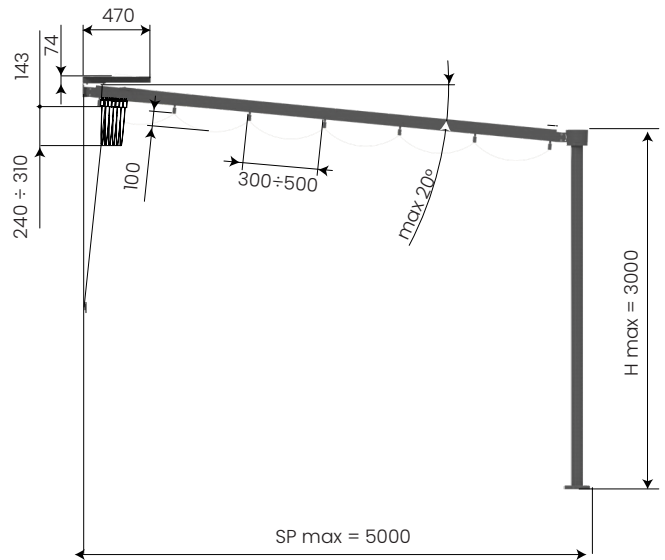
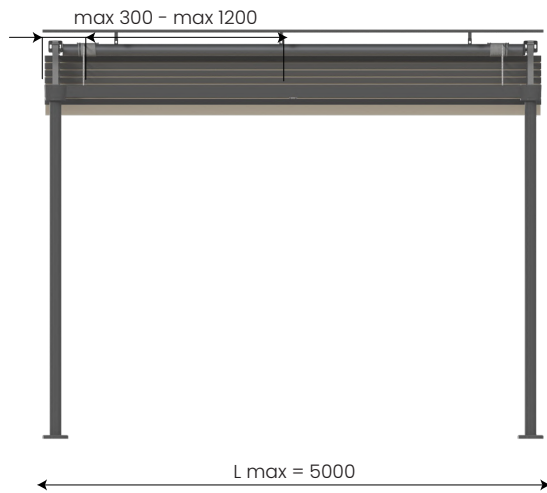

Le misure sono espresse in millimetri
Sizes are expressed in millimeters

Colori disponibili
Colours available

BISB bianco sablé
white sablé

G900 grafite sablé
graphite sablé



LEAF SKY

- Attacco parete/parete o soffitto/soffitto
- Utilizzabile anche sotto strutture e pergole preesistenti
- Versione manuale dimensione massima 600x700 cm

- Wall/wall or ceiling/ceiling installation
- It can be installed on pre-existing structures and pergolas
- Maximum size of the manual version: cm 600x700

Installazione a parete o soffitto senza colonne
Wall/ceiling installation (withouth columns)

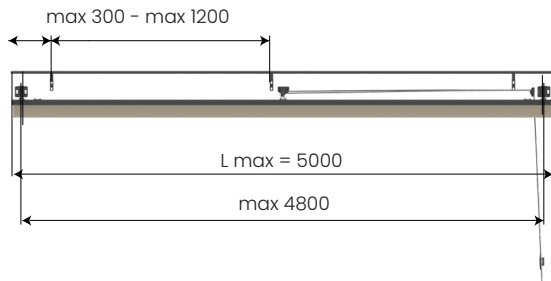

Le misure sono espresse in millimetri
Sizes are expressed in millimeters

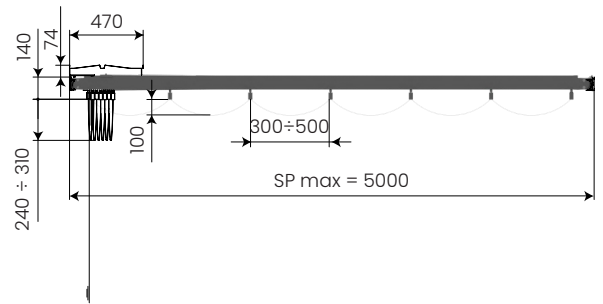

Colori disponibili
Colours available

BISB bianco sablé
white sablé

G900 grafite sablé
graphite sablé



Leaf rinforzata. leaf reinforced

TENDE VERTICALI. VERTICALS





Prodotto in Italia
Made in Italy



Tecnologia di ultima generazione
New generation technology



Versatili
Versatile



ILIOS. L'ELEGANTE

ILIOS. THE ELEGANT ONE

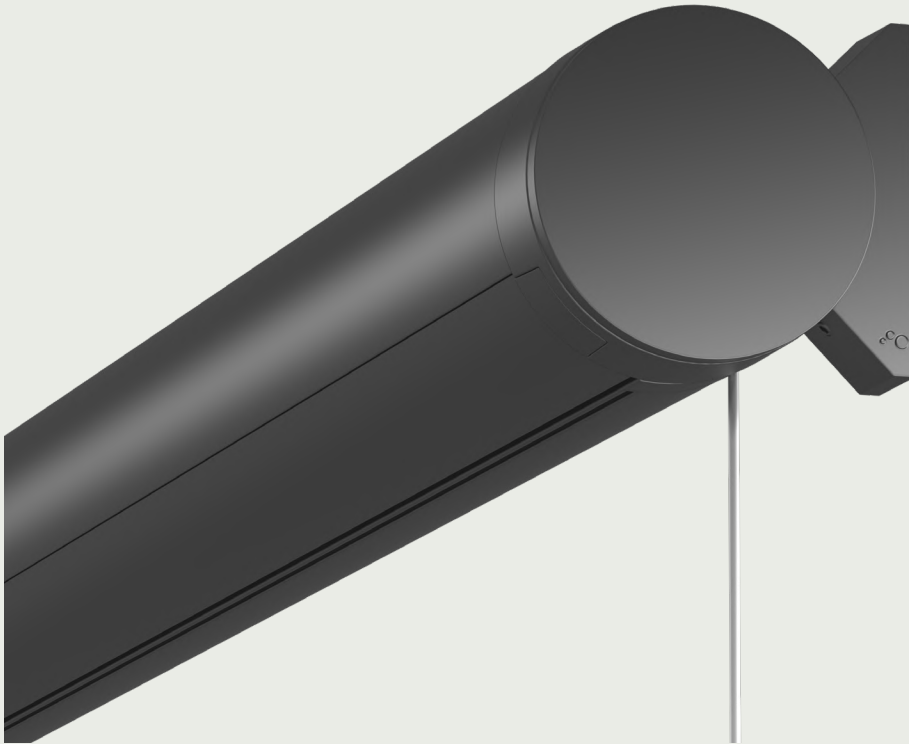

MAX 450x300 cm / 450x450 cm

REGISTERED DESIGN 



Tested by:  TÜVRheinland®
Precisely Right.

Caratteristiche generali

- Cassonetto con terminale a totale scomparsa
- Installazione a parete e soffitto
- Tubo avvolgitore da 80 mm
- Dimensioni massime 450x300 cm (tessuto acrilico)
- Con tessuto screen altezza massima 450 cm
- Manuale o motorizzata
- Viteria Inox certificata italiana
- Disponibile nella versione a cavetto (RAY)
- Certificazione TÜV Rheinland
- Design brevettato in tutti gli stati UE
- Vincitrice del Red Dot Design Award 2012

General features

- Terminal profile totally integrating with the box
- Wall and ceiling installation
- Roller tube 80 mm
- Maximum sizes 450x300 cm (acrylic fabric)
- Maximum height with screen fabric: 450 cm
- Manually operated or motorized
- Certified Italian Stainless steel screws and pins
- Available in the steel cable version (RAY)
- Certified by TÜV Rheinland
- Design patented in all EU Member States
- 2012 Red Dot Design Award winner

Dimensioni ingombro
Overall sizes

Installazione a parete o soffitto
Wall or ceiling installation

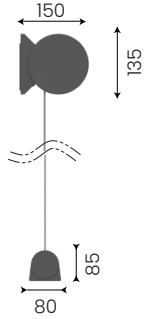

Installazione a parete o soffitto
Wall or ceiling installation

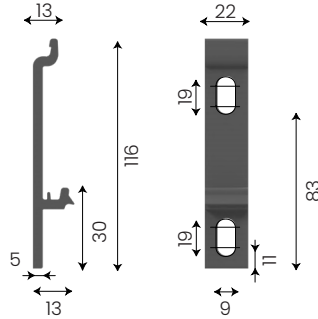

Dimensione kit piedino
Foot kit sizes

Cuffia
Foot cover

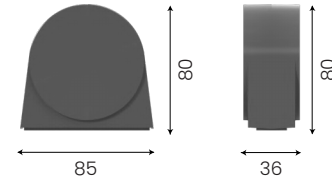

Staffa di ancoraggio
Anchoring bracket

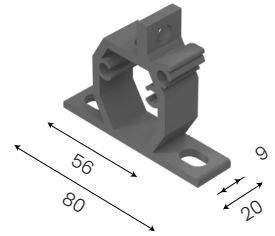

Le misure sono espresse in millimetri
Sizes are expressed in millimeters

Colori disponibili
Colours available

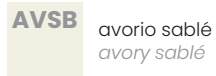

Premi
Awards

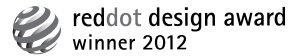



AIRE. LA SQUADRATA

AIRE. THE SHARP ONE

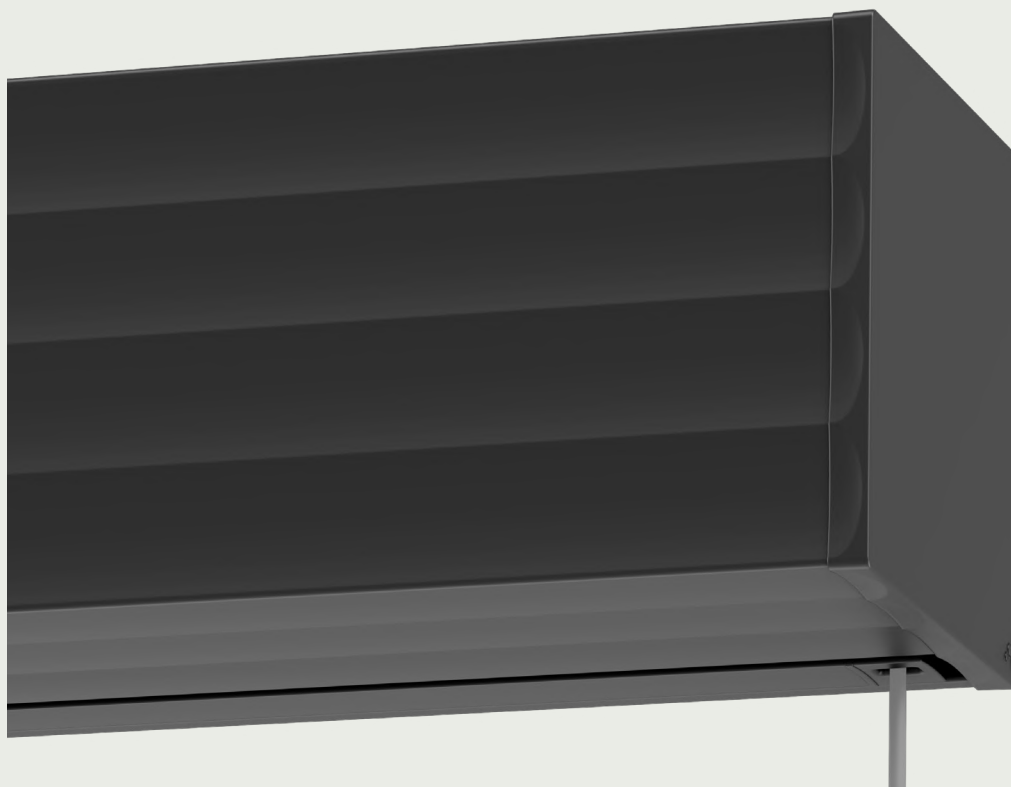

MAX 450x300 cm / 450x450 cm

REGISTERED DESIGN 



Tested by:  TÜVRheinland®
Precisely Right.

Tubo 

Caratteristiche generali

- Cassonetto con terminale a totale scomparsa
- Installazione a parete e soffitto
- 4 colori standard
- Tubo avvolgitore da 80 mm
- Viteria Inox certificata italiana
- Certificazione TÜV Rheinland
- Dimensioni massime 450x300 cm (tessuto acrilico)
- Con tessuto screen altezza massima 450 cm
- Manuale o motorizzata
- Design brevettato in tutti gli stati UE
- Vincitrice del Product Design Award 2013
- Vincitrice dell'Interior Innovation Award 2014

General features

- Terminal profile totally integrating with the box
- Wall and ceiling installation
- 4 standard colours
- Roller tube 80 mm
- Certified Italian Stainless steel screws and pins
- Certified by TÜV Rheinland
- Maximum sizes 450x300 cm (acrylic fabric)
- Maximum height with screen fabric: 450 cm
- Manually operated or motorized
- Design patented in all EU Member States
- 2013 Product Design Award winner
- 2014 Interior Innovation Award winner

Dimensioni ingombro
Overall sizes

Installazione a parete o soffitto
Wall or ceiling installation

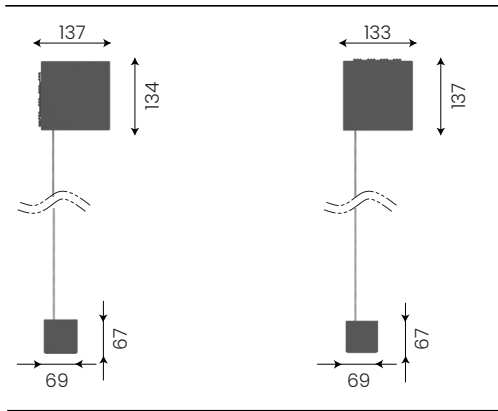

Le misure sono espresse in millimetri
Sizes are expressed in millimeters

Colori disponibili
Colours available

BISB	bianco sablé white sablé	GRSB	grigio chiaro sablé light grey sablé
AVSB	avorio sablé ivory sablé	G900	grafite sablé graphite sablé
CORT	corten corten		

Premi
Awards



TENDE ZIP SHIELD. ZIP SHIELD





Prodotto in Italia
Made in Italy



Wind resistance



Tensionamento intelligente
Intelligent Tensioning



Efficienza elastica
Elastic efficiency





Manuali e motorizzate
Manual and motorized

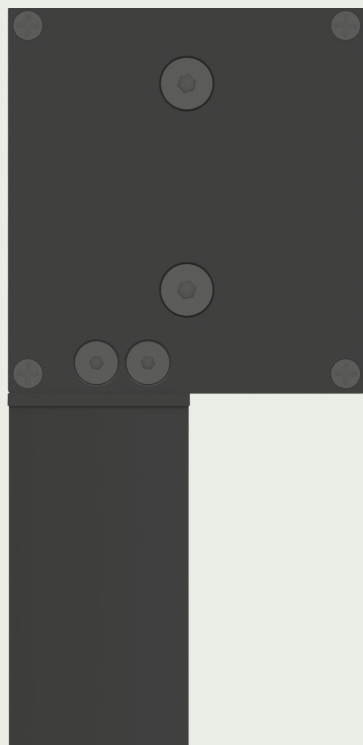

OTTANTA ZIP. LA PICCOLA

OTTANTA ZIP. THE SMALL ONE



 **MAX 220x250 cm**

REGISTERED DESIGN 

 5 YEAR WARRANTY

 ZIP SHIELD

 CLASSE 6

Caratteristiche generali

- Cassonetto da 80 mm
- Installazione autoportante
- Tubo avvolgitore da 60 mm
- Viteria Inox certificata italiana
- Dimensioni massime 220X250 cm
- Manuale o motorizzata
- Tessuto con cerniera laterale antivento
- 3 tipi di guarnizione per il terminale
- Guida tamponamento opzionale

General features

- *Cassette profile 80 mm*
- *Self-standing installation*
- *Roller tube 60 mm*
- *Certified Italian Stainless steel screws and pins*
- *Maximum sizes 220X250 cm*
- *Manually operated or motorized*
- *Fabric with anti-wind zip belt*
- *3 different type of terminal bar gasket*
- *Optional plugging guide*

Dimensioni ingombro
Overall sizes

Installazione a parete o soffitto
Wall or ceiling installation

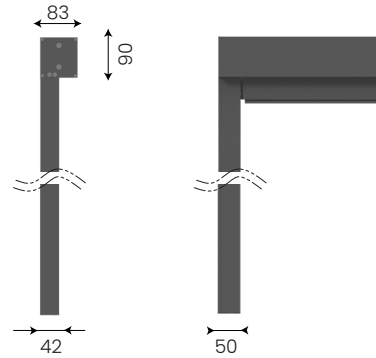

Guida 50
50 Guide

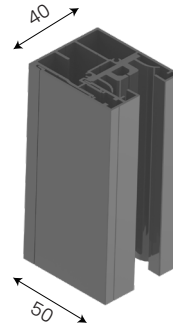

Copri guida incasso
Recessed guide cover

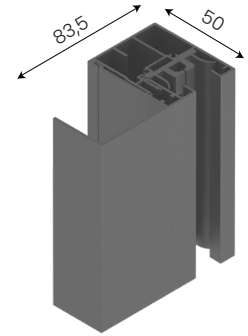

Le misure sono espresse in millimetri
Sizes are expressed in millimeters

Colori disponibili
Colours available

BISB	bianco sablé white sablé	GRSB	grigio chiaro sablé light grey sablé
AVSB	avorio sablé avory sablé	G900	grafite sablé graphite sablé
CORT	corten corten		

Terminale 50
50 Terminal

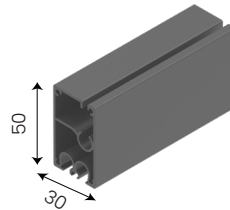



CENTO ZIP. L'AUTENTICA

CENTO ZIP. THE AUTHENTIC ONE

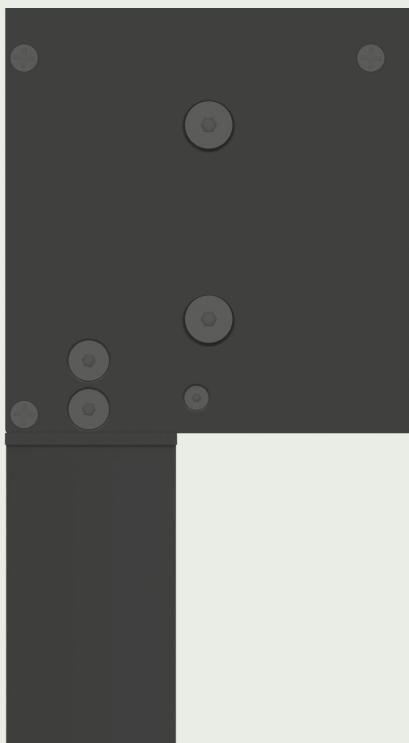

 **MAX 400x300 cm**

REGISTERED DESIGN 

 5 YEAR WARRANTY

 ZIP SHIELD

 CLASSE 6

Caratteristiche generali

- Cassonetto ispezionabile da 100 mm
- Installazione autoportante o soffitto (staffe optional)
- Tubo avvolgitore da 80 mm
- Viteria Inox certificata italiana
- Dimensioni massime 400x300 cm
- Manuale o motorizzata
- Disponibile con e senza cassonetto (FREE)
- Tessuto con cerniera laterale antivento
- 3 tipi di guarnizione per il terminale
- Locking-System opzionale
- Guida tamponamento opzionale
- Molle in polimero plastico per tensione telo

General features

- Inspectionable cassette profile 100 mm
- Self-standing and ceiling installation
- Roller tube 80 mm
- Certified Italian Stainless steel screws and pins
- Maximum sizes 400x300 cm
- Manually operated or motorized
- Available with or without box (FREE)
- Fabric with anti-wind zip belt
- 3 different type of terminal bar gasket
- Optional locking-system
- Optional plugging guide
- Plastic polymer springs for cloth tensioning

Cento Zip. L'autentica. cento zip. the authentic one

Dimensioni ingombro
Overall sizes

Blocco No Loop
No Loop Lock

Molle in plastica
Plastic springs

Blocco Smart Lock
Smart Lock

Molle in alluminio
Aluminium springs

Installazione a parete o soffitto
Wall or ceiling installation

Guida 50
50 Guide

Copri guida incasso
Recessed guide cover

Guida 66
66 Guide

Copri guida incasso
Recessed guide cover

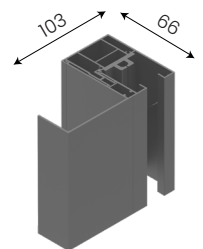
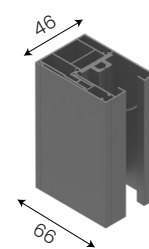
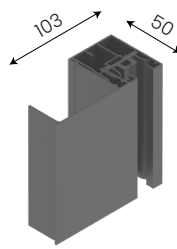
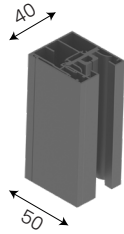
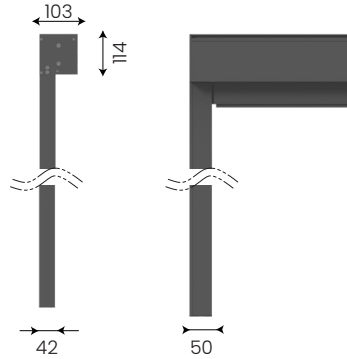

Le misure sono espresse in millimetri
Sizes are expressed in millimeters

Colori disponibili
Colours available

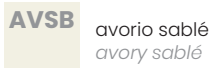

Terminale 50
50 Terminal

Terminale 73
73 Terminal

Staffa
Bracket

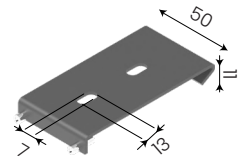
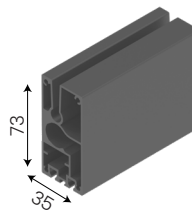
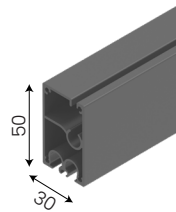



CENTOTRENTA ZIP. LA MEDIA

CENTOTRENTA ZIP. THE MEDIUM ONE

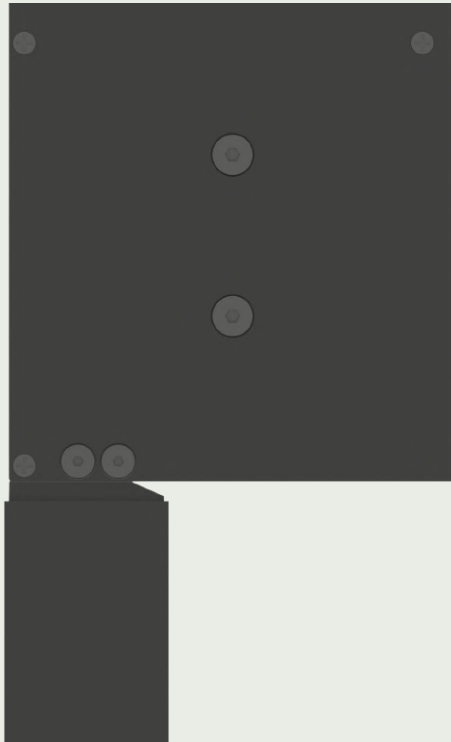

MAX 500x500 cm

REGISTERED DESIGN 



Caratteristiche generali

- Cassonetto ispezionabile da 130mm
- Installazione autoportante o soffitto (staffe optional)
- Tubo avvolgitore da 100 mm
- Viteria Inox certificata italiana
- Dimensioni massime 500x500 cm
- Manuale o motorizzata
- Disponibile con e senza cassonetto (FREE)
- Tessuto con cerniera laterale antivento
- Locking-System opzionale
- 3 tipi di guarnizione per il terminale
- Guida tamponamento opzionale

General features

- *Inspectionable cassette profile 130mm*
- *Self-standing and ceiling installation*
- *Roller tube 100 mm*
- *Certified Italian Stainless steel screws and pins*
- *Maximum sizes 500x500 cm*
- *Manually operated or motorized*
- *Available with or without box (FREE)*
- *Fabric with anti-wind zip belt*
- *Optional locking-system*
- *3 different type of terminal bar gasket*
- *Optional big cover guide*

Centotrenta zip. La media. centotrenta zip. the medium one

Dimensioni ingombro
Overall sizes

Blocco No Loop
No Loop Lock

Molle in plastica
Plastic springs

Blocco Smart Lock
Smart Lock

Molle in alluminio
Aluminium springs

Installazione a parete o soffitto
Wall or ceiling installation

Guida 50
50 Guide

Copri guida incasso
Recessed guide cover

Guida 66
66 Guide

Copri guida incasso
Recessed guide cover

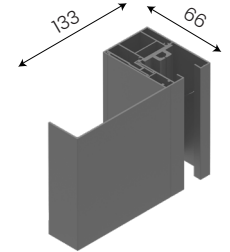
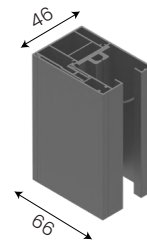
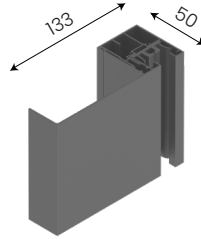
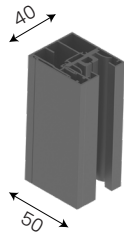
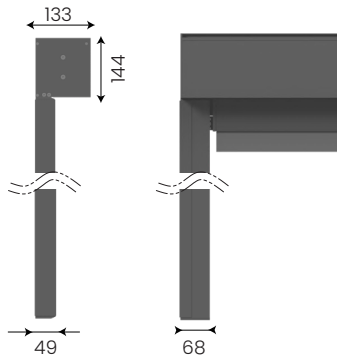

Le misure sono espresse in millimetri
Sizes are expressed in millimeters

Colori disponibili
Colours available

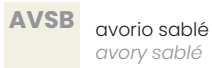

Terminale 73
73 Terminal

Staffa
Bracket

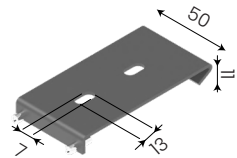
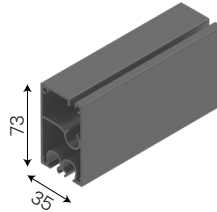



CENTOCINQUANTA ZIP. LA GRANDE

CENTOCINQUANTA ZIP. THE LARGE ONE

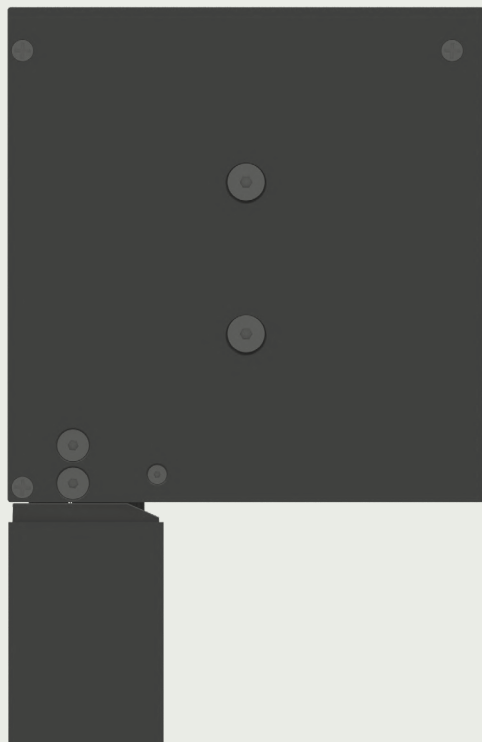

MAX 600x500 cm

REGISTERED DESIGN 



Caratteristiche generali

- Cassonetto ispezionabile da 150mm
- Installazione autoportante o soffitto (staffe optional)
- Tubo avvolgitore da 100 mm
- Viteria Inox certificata italiana
- Dimensioni massime 600x500 cm
- Manuale o motorizzata
- Disponibile con e senza cassonetto (FREE)
- Tessuto con cerniera laterale antivento
- Locking-System opzionale
- 3 tipi di guarnizione per il terminale
- Guida tamponamento opzionale

General features

- *Inspectionable cassette profile 150mm*
- *Self-standing and ceiling installation*
- *Roller tube 100 mm*
- *Certified Italian Stainless steel screws and pins*
- *Maximum sizes 600x500 cm*
- *Manually operated or motorized*
- *Available with or without box (FREE)*
- *Fabric with anti-wind zip belt*
- *Optional locking-system*
- *3 different type of terminal bar gasket*
- *Optional big cover guide*

Centocinquanta zip. La grande. centocinquanta zip. the large one

Dimensioni ingombro
Overall sizes

Blocco No Loop
No Loop Lock

Molle in plastica
Plastic springs

Blocco Smart Lock
Smart Lock

Molle in alluminio
Aluminium springs

Installazione a parete o soffitto
Wall or ceiling installation

Guida 50
50 Guide

Copri guida incasso
Recessed guide cover

Guida 66
66 Guide

Copri guida incasso
Recessed guide cover

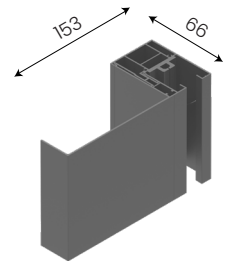
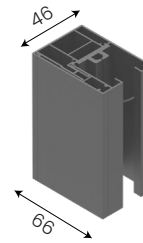
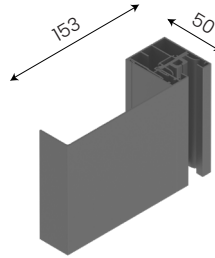
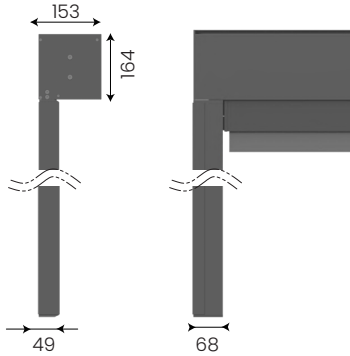

Le misure sono espresse in millimetri
Sizes are expressed in millimeters

Colori disponibili
Colours available

BISB bianco sablé
white sablé

GRSB grigio chiaro sablé
light grey sablé

AVSB avorio sablé
avory sablé

G900 grafite sablé
graphite sablé

CORT corten
corten

Terminale 73
73 Terminal

Staffa
Bracket

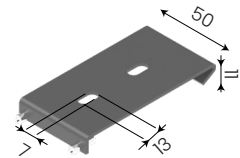
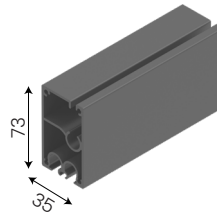

Sede legale. Headquarters

Via 1° maggio, 7
30029 San Stino di Livenza
Venezia, Italy

T. +39 0421 189 61 57
E. info@shadelab.it
W. shadelab.com

Seguici su . *Follow us on*





shadelab.com